



SOL UP011-3024

INVERTER / CHARGER

User's Manual

Table of Contents

ABOUT THIS MANUAL	1
Purpose	1
Scope	1
SAFETY INSTRUCTIONS	1
INTRODUCTION	2
Features	2
Basic System Architecture	2
Product Overview	3
INSTALLATION	4
Unpacking and Inspection	4
Preparation	4
Mounting the Unit	4
Battery Connection	5
AC Input/Output Connection	6
PV Connection	7
Final Assembly	8
Communication Connection	9
Dry Contact Signal	9
OPERATION	10
Power ON/OFF	10
Operation and Display Panel	10
LCD Display Icons	11
LCD Setting	13
Display Setting	17
Operating Mode Description	20
Fault Reference Code	21
Warning Indicator	22
SPECIFICATIONS	23
Table 1: Line Mode Specifications	23
Table 2: Inverter Mode Specifications	24
Table 3: Charging Mode Specifications	25
Table 4 General Specifications	25
TROUBLESHOOTING	26
Appendix I: Approximate Back-up Time Table	27
Appendix II: Parallel function	28

ABOUT THIS MANUAL

Purpose

This manual describes the assembly, installation, operation and troubleshooting of this unit. Please read this manual carefully before installations and operations. Keep this manual for future reference.

Scope

This manual provides safety and installation guidelines as well as information on tools and wiring.

SAFETY INSTRUCTIONS



WARNING: This chapter contains important safety and operating instructions. Read and keep this manual for future reference.

1. Before using the unit, read all instructions and warnings marked on the unit, the batteries and all appropriate sections of this manual.
2. **CAUTION** --To reduce risk of injury, charge it with only deep-cycle lead acid type rechargeable batteries. It might cause burst or result in physical injury and damage if you charge it with other types of the batteries.
3. Do not disassemble the unit at will. For servicing or repairs, it's advised to take it to an authorized service center. Incorrect re-assembly may result in a risk of electric shock or fire.
4. To reduce the risk of electric shock, unplug all wirings from the wall outlet before any maintenance or cleaning. Turning off the unit will not reduce this risk.
5. **CAUTION** – Only qualified personnel can install this device with battery.
6. **NEVER** charge a frozen battery.
7. For optimum operation of this inverter/charger, please follow required spec to select appropriate cable size. It's very important to correctly operate this inverter/charger.
8. Be very cautious when working with metal tools on or around the batteries. A potential risk exists when you drop tools on or around the batteries. Spark, short circuited batteries or other electrical parts might cause an explosion.
9. Please strictly follow installation procedure when you want to disconnect AC or DC terminals. Please refer to the INSTALLATION section of this manual for the details.
10. Fuses are provided for over-current protection of the battery supply.
11. **GROUNDING INSTRUCTIONS** -This inverter/charger should be connected to a permanent grounded wiring system. Be sure to comply with local requirements and regulation to install this inverter.
12. **NEVER** cause AC output and DC input short circuited. Do NOT connect to the mains when DC input short circuits.
13. **Warning!!** Only qualified service staffs are able to operate this device. If errors still persist after following the troubleshooting table, please send this inverter/charger back to the local dealer or service center for maintenance.

INTRODUCTION

This is a multi-functional inverter/charger, combining the functions of inverter, PWM/MPPT solar charger and battery charger to offer uninterruptible power support with portability. Its comprehensive LCD display offers user-configurable and easy-accessible button operation such as battery charging current, priority setting for AC/solar charger, and acceptable input voltage setting to suit different applications.

Features

- Pure sine wave inverter
- Built-in PWM/MPPT solar charge controller
- Configurable input voltage range for home appliances and personal computers via LCD setting
- Configurable battery charging current to suit different applications via LCD setting
- Configurable priority of AC/Solar Charger via LCD setting
- Compatible to mains voltage or generator power
- Automatic restart while AC is recovering
- Overload/ Over temperature/ short circuit protection
- Smart battery charger design to optimize battery performance
- Cold start function

Basic System Architecture

The following illustration shows basic application of this inverter/charger. It also includes the following devices to complete the whole running system:

- Generator or Utility.
- PV modules

Consult your system integrator for other possible system architectures depending on your requirements.

This inverter can power all kinds of appliances at home or in the office, including motor-type appliances such as tube light, fan, refrigerator and air conditioner.

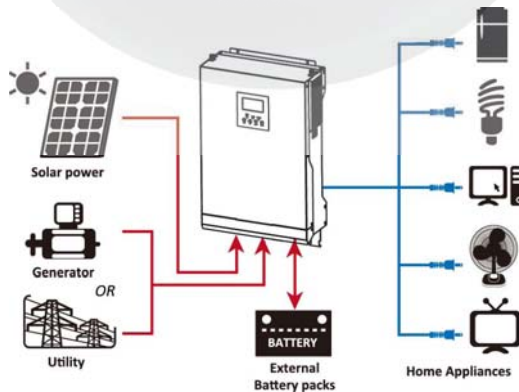
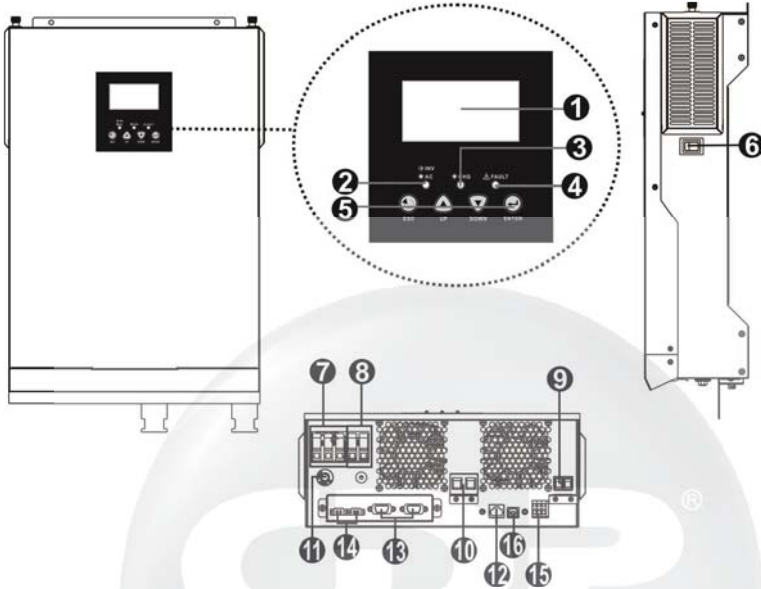

Figure 1 Hybrid Power System

Product Overview



- 1. LCD display
- 2. Status indicator
- 3. Charging indicator
- 4. Fault indicator
- 5. Function buttons
- 6. Power on/off switch
- 7. AC input
- 8. AC output
- 9. PV input
- 10. Battery input
- 11. Circuit breaker
- 12. RS232 communication port
- 13. Parallel communication port (only for parallel model)
- 14. Current sharing port (only for parallel model)
- 15. Dry contact
- 16. USB communication port

INSTALLATION

Unpacking and Inspection

Before installation, please inspect the unit. Be sure that nothing inside the package is damaged. You should have received the following items inside the package:

- The unit x 1
- User manual x 1
- Communication cable x 1
- Software CD x 1

Preparation

Before connecting all wirings, please take off the cover of the bottom by removing the two screws as shown below.

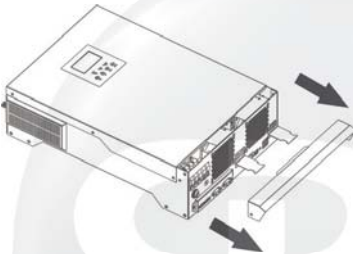

Mounting the Unit

Consider the following points before selecting where to install:

- Do not mount the inverter on any flammable construction materials.
- Mount this inverter on a solid surface
- Install this inverter at eye level in order to read the LCD display at all times.
- The ambient temperature should be between 0°C and 55°C to ensure optimal operation.
- The inverter should be adhered to the wall vertically.
- Be sure to keep other objects away and leave the space in a minimum as shown in the right diagram to guarantee sufficient heat dissipation and enough space for replacing wires.

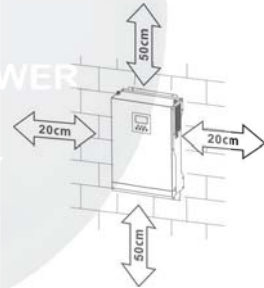

SUITABLE FOR MOUNTING ON CONCRETE OR OTHER NON-COMBUSTIBLE SURFACE ONLY.

Install the unit by screwing two screws as shown in the diagram. It's recommended to use M4 or M5 screws.

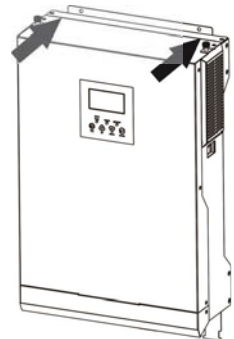

Battery Connection

CAUTION: For safety operation and regulation compliance, it's requested to install a separate DC over-current protector or disconnect the device between battery and inverter. It may not be necessary to disconnect the device for some applications, however, it's requested to have over-current protection installed. Please refer to the typical amperage in the table below as required fuse or size of the breaker.

WARNING! All wiring must be performed by a qualified personnel.

WARNING! It's very important for system safety and efficient operation to use appropriate cable for battery connection. To reduce risk of injury, please use proper cables and suitable size of terminal recommended below.

Recommended battery cables and size of terminal:

Model	Typical Amperage	Battery Capacity	Wire Size	Torque Value
3KVA 24V	100A	100AH/200AH	1*4AWG	2~ 3 Nm

Please follow the steps below to implement the battery connection:

1. Remove insulation sleeve 18 mm for positive and negative conductors.
2. Suggest to put bootlace ferrules on the end of positive and negative wires with a proper crimping tool.
3. Fix strain relief plate to the inverter by supplied screws as shown in below chart.

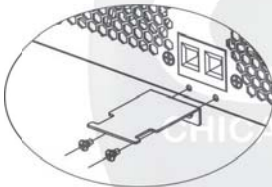

4. Connect all battery packs as below chart.

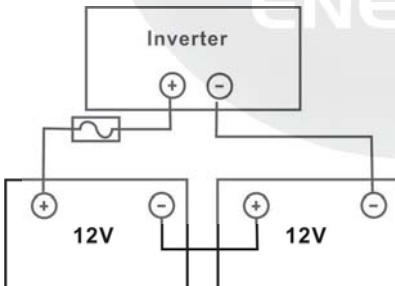

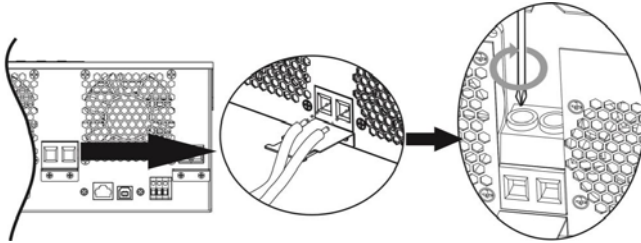

5. Insert the battery wires flatly into battery connectors of inverter and make sure the bolts are tightened with torque of 2 Nm in clockwise direction. Make sure polarity at both the battery and the inverter/charge is correctly connected and conductors are tightly screwed into the battery terminals.

Recommended tool: #2 Pozzi Screwdriver

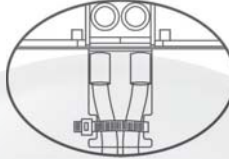

6. To firmly secure wire connection, you may fix the wires to strain relief with cable tie.



 **WARNING: Shock Hazard**
Installation must be performed with care due to high battery voltage in series.

 **CAUTION!!** Do not place anything between the flat part of the inverter terminal and the ring terminal. Otherwise, overheating may occur.
CAUTION!! Do not apply any anti-oxidant substance on the terminals before the terminals are connected tightly.
CAUTION!! Before making the final DC connection or closing DC breaker/disconnector, be sure positive (+) must be connected to positive (+) and negative (-) must be connected to negative (-).

AC Input/Output Connection

CAUTION!! Before connecting to AC input power source, please install a **separate** AC breaker between inverter and AC input power source. This will ensure the inverter can be securely disconnected during maintenance and fully protected from over current of AC input. The recommended spec of AC breaker is 40A for 3KVA.

CAUTION!! There are two terminal blocks with "IN" and "OUT" markings. Please do NOT mis-connect input and output connectors.

WARNING! All wiring must be performed by the qualified personnel.

WARNING! It's very important for system safety and efficient operation to use appropriate cable for AC input connection. To reduce risk of injury, please use the recommended cable size as below.

Suggested cable requirement for AC wires

Gauge	Torque Value
8 AWG	1.4~ 1.6Nm

Please follow below steps to implement AC input/output connection:

1. Before making AC input/output connection, be sure to open DC protector or disconnector first.
2. Remove insulation sleeve 10mm from the six conductors. And short-circuit phase L and neutral conductor N 3 mm.
3. Insert AC input wires according to polarities indicated on terminal block and tighten the terminal screws. Be

sure to connect PE protective conductor (⊕) first.

- ⊕ → **Ground (yellow-green)**
- L → **LINE (brown or black)**
- N → **Neutral (blue)**

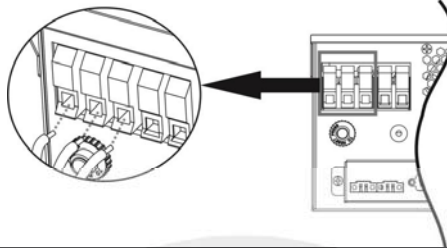

WARNING: Be sure that AC power source is disconnected before attempting to hardwire it to the unit.

4. Then, insert AC output wires according to polarities indicated on terminal block and fasten the terminal screws. Be sure to connect PE protective conductor (⊕) first.

- ⊕ → **Ground (yellow-green)**
- L → **LINE (brown or black)**
- N → **Neutral (blue)**

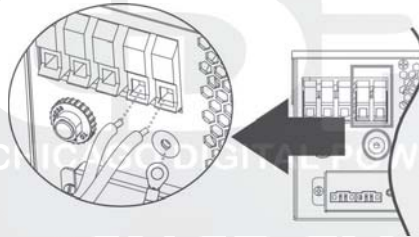

5. Make sure the wires are securely connected.

CAUTION: Important

Be sure to connect AC wires with correct polarity. If L and N wires are connected reversely, it may cause utility short-circuited when these inverters are worked in parallel operation.

CAUTION: Appliances such as air conditioner are required at least 2~3 minutes to restart because it's required to have enough time to balance refrigerant gas inside of circuits. If a power shortage occurs and recovers in a short time, it will cause damage to your connected appliances. To prevent this kind of damage, please check with the manufacturer of the air conditioner if it's equipped with time-delay function before installation. Otherwise, this inverter/charger will cause overload fault and cut off the output to protect your appliance but sometimes it still causes internal damage to the air conditioner.

PV Connection

CAUTION: Before connecting to PV modules, please install **separately** a DC circuit breaker between inverter and PV modules.

WARNING! All wiring must be performed by a qualified personnel.

WARNING! It's very important for system safety and efficient operation to use appropriate cable for PV module connection. To reduce risk of injury, please use the recommended cable size as below.

Model	Typical Amperage	Cable Size	Torque
Model with PWM	50A	8 AWG	1.4~1.6 Nm
Model with MPPT	80A	6 AWG	1.4~1.6 Nm

PV Module Selection:

When selecting proper PV modules, please be sure to consider the parameters below:

1. Open circuit Voltage (Voc) of PV modules can't exceed the maximum voltage of the PV array open circuit of the inverter.
2. Open circuit Voltage (Voc) of PV modules should be higher than the minimum voltage of the battery.

Solar Charging Mode		
Solar Charger Type	PWM	MPPT
Max. PV Array Open Circuit Voltage	80Vdc	145Vdc
PV Array MPPT Voltage Range	N/A	30~80Vdc
Operating Voltage Range	30~40Vdc	N/A
Min. battery voltage for PV charge	17Vdc	34Vdc

Please follow the steps below to implement PV module connection:

1. Remove insulation sleeve 10 mm from positive and negative conductors.
2. Check the correct polarity of connected cable from PV modules and PV input connectors. Then, connect positive pole (+) of connection cable to positive pole (+) of PV input connector. Connect negative pole (-) of connection cable to negative pole (-) of PV input connector.

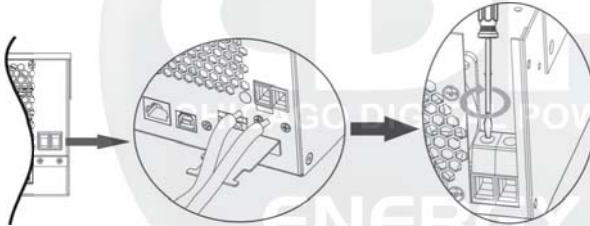

3. Make sure the wires are securely connected.

Final Assembly

After connecting all wirings, please put the bottom cover back by fixing two screws as shown below.

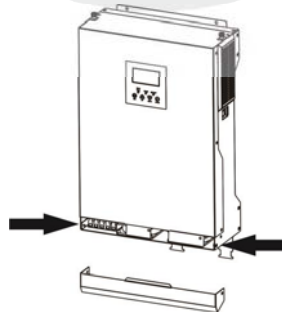

Communication Connection

Please use supplied communication cable to connect to inverter and PC. Insert bundled CD into a computer and follow the on-screen instructions to install the monitoring software. For the detailed software operations, please check user manual of software inside the CD.

Dry Contact Signal

There is one dry contact (3A/120VAC) available on the rear panel. It could be used to deliver signal to external device when battery voltage reaches warning level.

Unit Status	Condition		Dry contact port: 		
			NC & C	NO & C	
Power Off	Unit is off and no output is powered.		Close	Open	
Power On	Output is powered from Utility.		Close	Open	
	Output is powered from Battery or Solar.	Program 01 set as Utility	Battery voltage < Low DC warning voltage	Open	Close
			Battery voltage > Setting value in Program 13 or battery charging reaches floating stage	Close	Open
	Program 01 is set as SBU or Solar first		Battery voltage < Setting value in Program 12	Open	Close
		Battery voltage > Setting value in Program 13 or the battery charging reaches the floating stage	Close	Open	

OPERATION

Power ON/OFF



Once the unit has been properly installed and the batteries are connected well, simply press On/Off switch (located on the right corner of the rear panel) to turn on the unit.

Operation and Display Panel

The operation and display panel, as shown in the chart below, are on the front panel of the inverter. It includes three indicators, four function keys and an LCD display, indicating the operating status and input/output power information.

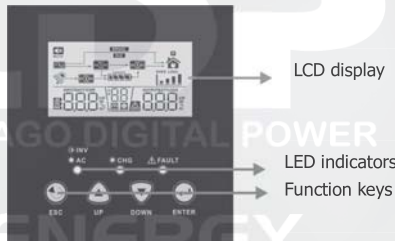

LED Indicator

LED Indicator		Messages	
INV AC	Green	Solid On	Output is powered by utility in Line mode.
		Flashing	Output is powered by battery or PV in battery mode.
CHG	Green	Solid On	Battery is fully charged.
		Flashing	Battery is charging.
FAULT	Red	Solid On	Fault occurs in the inverter.
		Flashing	Warning occurs in the inverter.

Function Keys

Function Key	Description
ESC	To exit setting mode
UP	To go to previous selection
DOWN	To go to next selection
ENTER	To confirm the selection in setting mode or enter setting mode

LCD Display Icons

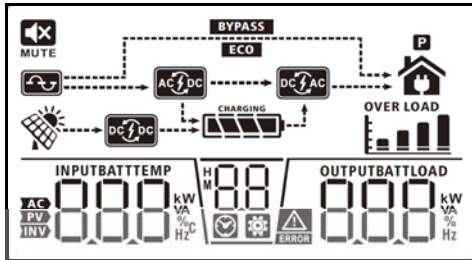

Icon	Function description	
Input Source Information		
	Indicates the AC input.	
	Indicates the PV input	
	Indicate input voltage, input frequency, PV voltage, battery voltage and charger current.	
Configuration Program and Fault Information		
	Indicates the setting programs.	
	Indicates the warning and fault codes. Warning: flashing with warning code. Fault: lighting with fault code	
Output Information		
	Indicate output voltage, output frequency, load percent, load in VA, load in Watt and discharging current.	
Battery Information		
	Indicates battery level by 0-24%, 25-49%, 50-74% and 75-100% in battery mode and charging status in line mode.	
In AC mode, it will	present battery charging status.	
Status	Battery voltage	LCD Display
Constant Current mode / Constant Voltage mode	<2V/cell	4 bars will flash in turns.
	2 ~ 2.083V/cell	Bottom bar will be on and the other three bars will flash in turns.
	2.083 ~ 2.167V/cell	Bottom two bars will be on and the other two bars will flash in turns.
	> 2.167 V/cell	Bottom three bars will be on and the top bar will flash.
Floating mode. Batteries are fully charged.		4 bars will be on.

In battery mode, it will present battery capacity.				
Load Percentage	Battery Voltage	LCD Display		
Load > 50%	< 1.717V/cell			
	1.717V/cell ~ 1.8V/cell			
	1.8 ~ 1.883V/cell			
	> 1.883 V/cell			
50% > Load > 20%	< 1.817V/cell			
	1.817V/cell ~ 1.9V/cell			
	1.9 ~ 1.983V/cell			
	> 1.983			
Load < 20%	< 1.867V/cell			
	1.867V/cell ~ 1.95V/cell			
	1.95 ~ 2.033V/cell			
	> 2.033			
Load Information				
OVER LOAD	Indicates overload.			
	Indicates the load level by 0-24%, 25-49%, 50-74% and 75-100%.			
	0%~24%	25%~49%	50%~74%	75%~100%
Mode Operation Information				
	Indicates unit connects to the mains.			
	Indicates unit connects to the PV panel.			
BYPASS	Indicates load is supplied by utility power.			
	Indicates the utility charger circuit is working.			
	Indicates the PV charger circuit is working.			
	Indicates the DC/AC inverter circuit is working.			
Mute Operation				
	Indicates unit alarm is disabled.			

LCD Setting

After pressing and holding the ENTER button for 3 seconds, the unit will enter setting mode. Press "UP" or "DOWN" button to select setting programs. And then, press "ENTER" button to confirm the selection or ESC button to exit.





Setting Programs:

Program	Description	Selectable option	
00	Exit setting mode	Escape 00 ESC	
01	Output source priority: To configure load power source priority	Solar first 01 SOL	Solar energy provides power to the loads as first priority. If solar energy is not sufficient to power all connected loads, battery energy will supply power to the loads at the same time. Utility provides power to the loads only when any one condition stated below happens: - Solar energy is not available - Battery voltage drops to either low DC warning voltage or the setting point in program 12.
		Utility first (default) 01 UTI	Utility will provide power to the loads as first priority. Solar and battery energy will provide power to the loads only when utility power is not available.
		SBU priority 01 SBU	Solar energy provides power to the loads as first priority. If solar energy is not sufficient to power all connected loads, battery energy will supply power to the loads at the same time. Utility provides power to the loads only when battery voltage drops to either low DC warning voltage or the setting point in program 12.
02	Maximum charging current: To configure the total charging current for solar and utility chargers. (Max. charging current = utility charging current + solar charging current)	10A 02 10 ^A	20A 02 20 ^A

02	Maximum charging current: To configure the total charging current for solar and utility chargers. (Max. charging current = utility charging current + solar charging current)	30A 02 30 ^A	40A 02 40 ^A
		50A 02 50 ^A	60A (default) 02 60 ^A
		70A 02 70 ^A	80A 02 80 ^A
		90A 02 90 ^A	100A 02 100 ^A
		110A 02 110 ^A	120A (only for 3KVA with MPPT models) 02 120 ^A
		130A (only for 3KVA with MPPT models) 02 130 ^A	140A (only for 3KVA with MPPT models) 02 140 ^A
		03	AC input voltage range
UPS 03 UPS	If selected, acceptable AC input voltage range will be within 170-280VAC.		
04	Power saving mode enable/disable	Saving mode disable (default) 04 SDS	If disabled, no matter connected load is low or high, the on/off status of inverter output will not be effected.
		Saving mode enable 04 SEN	If enabled, the output of inverter will be off when connected load is pretty low or not detected.
05	Battery type	AGM (default) 05 AGM	Flooded 05 FLD

		User-Defined 05 USE	If "User-Defined" is selected, battery charge voltage and low DC cut-off voltage can be set up in program 26, 27 and 29.
06	Automatically restart when overload occurs	Restart disable (default) 06 LTD	Restart enable 06 LFE
07	Automatically restart when over temperature occurs	Restart disable (default) 07 LTD	Restart enable 07 LFE
08	Output voltage	110V 08 110 _v	120V (default) 08 120 _v
09	Output frequency	50Hz (default) 09 50 _{Hz}	60Hz 09 60 _{Hz}
11	Maximum utility charging current	2A 11 2A	10A 11 10A
		20A 11 20A	30A (default) 11 30A
		40A 11 40A	50A 11 50A
		60A 11 60A	
12	Setting voltage point back to utility source when selecting "SBU priority" or "Solar first" in program 01.	Default setting: 23.0V 12 23.0 _{BATT} _v	Setting range is from 22.0V to 25.5V and increment of each click is 0.5V
13	Setting voltage point back to battery mode when selecting "SBU priority" or "Solar first" in program 01.	Battery fully charged 13 FUL	Default setting: 27.0V 13 27.0 _{BATT} _v
16	Charger source priority: To configure the priority of	If this inverter/charger is working in Line, Standby or Fault mode, charger source can be programmed as below:	



	charger source	Solar first 16 C50	Solar energy will charge battery as first priority. Utility will charge battery only when solar energy is not available.
		Utility first 16 C06	Utility will charge battery as first priority. Solar energy will charge battery only when utility power is not available.
		Solar and Utility 16 S0U	Solar energy and utility will charge battery at the same time.
		Only Solar 16 050	Solar energy will be the only charger source no matter utility is available or not.
		If this inverter/charger is working in Battery mode or Power saving mode, only solar energy can charge battery. Solar energy will charge battery if it's available and sufficient.	
18	Alarm control	Alarm on (default) 18 60N	Alarm off (Ⓡ) 18 60F
19	Automatically return to default display screen	Return to default display screen (default) 19 C5P	If selected, no matter how users switch display screen, it will automatically return to default display screen (Input voltage /output voltage) after no button is pressed for 1 minute.
		Stay at latest screen 19 F5P	If selected, the display screen will stay at the latest screen user finally switches.
20	Backlight control	Backlight on (default) 20 L0N	Backlight off 20 L0F
22	Beeps while primary source is interrupted	Alarm on (default) 22 A0N	Alarm off 22 A0F
23	Overload bypass: When enabled, the unit will transfer to line mode if overload occurs in battery mode.	Bypass disable (default) 23 6YD	Bypass enable 23 6YE
		Record enable 25 FEN	Record disable (default) 25 FDS
25	Record Fault code		

26	Bulk charging voltage (C.V voltage)	<p>default setting: 28.2V</p>  <p>If self-defined is selected in program 5, this program can be set up. Setting range is from 24.0V to 29.2V. Increment of each click is 0.1V.</p>	
27	Floating charging voltage	<p>default setting: 27.0V</p>  <p>If self-defined is selected in program 5, this program can be set up. Setting range is from 24.0V to 29.2V, Increment of each click is 0.1V.</p>	
29	Low DC cut-off voltage	<p>default setting: 21.0V</p>  <p>If self-defined is selected in program 5, this program can be set up. Setting range is from 20.0V to 24.0V. Increment of each click is 0.1V. Low DC cut-off voltage will be fixed to setting value no matter what percentage of load is connected.</p>	
31	Solar power balance: When enabled, solar input power will be automatically adjusted according to the connected load power.	<p>Solar power balance enable (Default):</p> 	<p>If selected, solar input power will be automatically adjusted according to the following formula: Max. input solar power = Max. battery charging power + Connected load power.</p>
		<p>Solar power balance disable:</p> 	<p>If selected, the solar input power will be the same as max. battery charging power no matter how many loads are connected. The max. battery charging power will be based on the setting current in program 02. (Max. solar power = Max. battery charging power)</p>

Display Setting

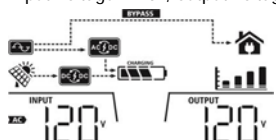

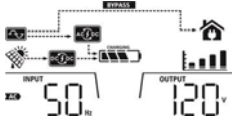
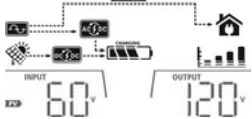
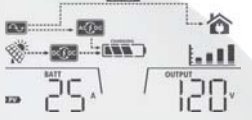
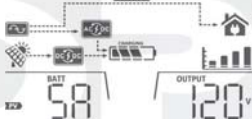
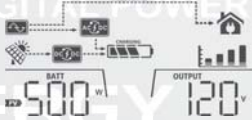

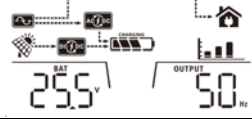
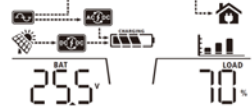

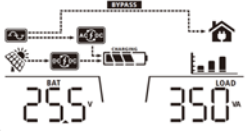
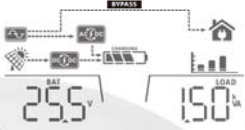
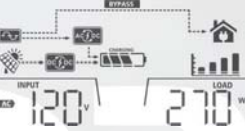
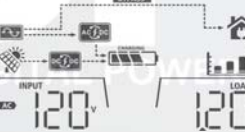
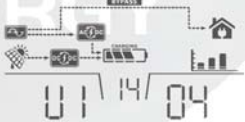
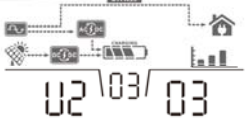
The LCD display information will be switched in turns by pressing "UP" or "DOWN" key. The selectable information is switched as below order: input voltage, input frequency, PV voltage, MPPT charging current, MPPT charging power, battery voltage, output voltage, output frequency, load percentage, load in VA, load in Watt, DC discharging current, main CPU Version and second CPU Version.

Selectable information	LCD display
Input voltage/Output voltage (Default Display Screen)	<p>Input Voltage=120V, output voltage=120V</p> 





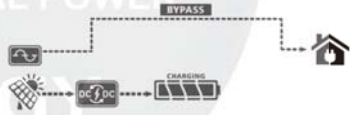
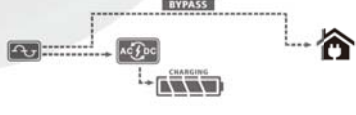











<p>Input frequency</p>	<p>Input frequency=50Hz</p> 
<p>PV voltage</p>	<p>PV voltage=60V</p> 
<p>MPPT Charging current</p>	<p>Current $\geq 10A$</p>  <p>Current < 10A</p> 
<p>MPPT Charging power</p>	<p>MPPT charging power=500W</p> 
<p>Battery voltage/ DC discharging current</p>	<p>Battery voltage=25.5V, discharging current=1A</p> 
<p>Output frequency</p>	<p>Output frequency=50Hz</p> 
<p>Load percentage</p>	<p>Load percent=70%</p> 

<p>Load in VA</p>	<p>When connected load is lower than 1kVA, load in VA will present xxxVA like the chart below.</p>  <p>When load is larger than 1kVA ($\geq 1\text{kVA}$), load in VA will present x.xkVA like the chart below.</p> 
<p>Load in Watt</p>	<p>When load is lower than 1kW, load in W will present xxxW like the chart below.</p>  <p>When load is larger than 1kW ($\geq 1\text{kW}$), load in W will present x.xkW like the chart below.</p> 
<p>Main CPU version checking</p>	<p>Main CPU version: 00014.04</p> 
<p>Secondary CPU version checking</p>	<p>Secondary CPU version: 00003.03</p> 









Operating Mode Description

Operation mode	Description	LCD display
<p>Standby mode / Power saving mode</p> <p>Note:</p> <p>*Standby mode: The inverter is not turned on yet but at this time, the inverter can charge battery without AC output.</p> <p>*Power saving mode: If enabled, the output of inverter will be off when connected load is pretty low or not detected.</p>	<p>No output is supplied by the unit but it still can charge the batteries.</p>	<p>Charging by utility.</p> 
		<p>Charging by PV energy.</p> 
		<p>No charging.</p> 
<p>Fault mode</p> <p>Note:</p> <p>*Fault mode: Errors are caused by internal circuit errors or external reasons such as over temperature, output short circuited and so on.</p>	<p>PV energy can charge the batteries.</p>	<p>Charging by PV energy.</p> 
		<p>No charging.</p> 
<p>Line Mode</p>	<p>The unit will provide output power from the mains. It will also charge the battery in line mode.</p>	<p>Charging by PV energy</p> 
		<p>Charging by utility.</p> 
<p>Battery Mode</p>	<p>The unit will provide output power from battery and PV power.</p>	<p>Power from battery and PV energy.</p> 
		<p>Power from battery only.</p> 

Fault Reference Code

Fault Code	Fault Event	Icon on
01	Fan is locked when inverter is off.	
02	Over temperature	
03	Battery voltage is too high	
04	Battery voltage is too low	
05	Output short circuited or over temperature is detected by internal converter components.	
06	Output voltage is too high.	
07	Overload time out	
08	Bus voltage is too high	
09	Bus soft start failed	
11	Main relay failed	
51	Over current or surge	
52	Bus voltage is too low	
53	Inverter soft start failed	
55	Over DC voltage in AC output	
56	Battery connection is open	
57	Current sensor failed	
58	Output voltage is too low	

Warning Indicator

Warning Code	Warning Event	Audible Alarm	Icon flashing
01	Fan is locked when inverter is on.	Beep three times every second	
03	Battery is over-charged	Beep once every second	
04	Low battery	Beep once every second	
07	Overload	Beep once every 0.5 second	 OVER LOAD
10	Output power derating	Beep twice every 3 seconds	
12	Solar charger stops due to low battery.		
13	Solar charger stops due to high PV voltage.		
14	Solar charger stops due to overload.		

SPECIFICATIONS

Table 1: Line Mode Specifications

INVERTER MODEL	3KVA
Input Voltage Waveform	Sinusoidal (utility or generator)
Nominal Input Voltage	120Vac
Low Loss Voltage	95Vac±7V (UPS) 65Vac±7V (Appliances)
Low Loss Return Voltage	100Vac±7V (UPS); 70Vac±7V (Appliances)
High Loss Voltage	140Vac±7V
High Loss Return Voltage	135Vac±7V
Max AC Input Voltage	150Vac
Nominal Input Frequency	50Hz / 60Hz (Auto-detection)
Low Loss Frequency	40±1Hz
Low Loss Return Frequency	42±1Hz [®]
High Loss Frequency	65±1Hz
High Loss Return Frequency	63±1Hz
Output Short Circuit Protection	Line mode: Circuit Breaker Battery mode: Electronic Circuits
Max bypass current	40A
Efficiency (Line Mode)	>95% (Rated R load, battery full charged)
Transfer Time	10ms typical (UPS); 20ms typical (Appliances)
Output power derating: When AC input voltage drops to 95V, the output power will be derated.	120Vac model: 

Table 2: Inverter Mode Specifications

INVERTER MODEL	3KVA
Rated Output Power	3KVA/2.4KW
Output Voltage Waveform	Pure Sine Wave
Output Voltage Regulation	110/120VAC±5%
Output Frequency	60Hz or 50Hz
Peak Efficiency	90%
Overload Protection	5s@≥150% load; 10s@110%~150% load
Surge Capacity	2* rated power for 5 seconds
Nominal DC Input Voltage	24Vdc
Cold Start Voltage	23.0Vdc
Low DC Warning Voltage @ load < 20% @ 20% ≤ load < 50% @ load ≥ 50%	22.0Vdc 21.4Vdc 20.2Vdc
Low DC Warning Return Voltage @ load < 20% @ 20% ≤ load < 50% @ load ≥ 50%	23.0Vdc 22.4Vdc 21.2Vdc
Low DC Cut-off Voltage @ load < 20% @ 20% ≤ load < 50% @ load ≥ 50%	21.0Vdc 20.4Vdc 19.2Vdc
High DC Recovery Voltage	29Vdc
High DC Cut-off Voltage	30Vdc
No Load Power Consumption	<50W
Saving Mode Power Consumption	<15W

Table 3: Charging Mode Specifications

Utility Charging Mode		
INVERTER MODEL		3KVA
Charging Current (UPS) @ Nominal Input Voltage		2/10A/20/30A/40/50/60A
Bulk Charging Voltage	Flooded Battery	29.2
	AGM / Gel Battery	28.2
Floating Charging Voltage		27Vdc
Charging Algorithm		3-Step
<div style="display: flex; align-items: center;"> <div style="flex: 1;"> <p>Charging Curve</p> </div> <div style="flex: 2;"> <p>The graph plots Battery Voltage (per cell) on the left y-axis (ranging from 24.00V to 2.700V) and Charging Current (%) on the right y-axis (ranging from 0% to 100%) against Time on the x-axis. The voltage curve (black line) rises linearly in the Bulk stage, levels off in the Absorption stage, and then slightly drops in the Maintenance stage. The current curve (red line) rises to 100% in the Bulk stage, remains constant in the Absorption stage, and then decays to 0% in the Maintenance stage. Key time points T_0 and T_1 are marked on the x-axis. A note indicates $T_1 = 10^* \text{Hr. (Absorption Max. Recommended)}$.</p> </div> </div>		
Solar Charging Mode		
INVERTER MODEL	3KVA with PWM	3KVA with MPPT
Rated Power	1250W	2000W
Max. efficiency	98.5%	98%
Max. PV Array Open Voltage	80Vdc	145Vdc
Operating Voltage Range	30~40Vdc	N/A
PV Array MPPT Voltage Range	N/A	30~80Vdc
Min. battery voltage for PV charge	17Vdc	
Standby Power Consumption	2W	
Battery Voltage Accuracy	+/-0.3%	
PV Voltage Accuracy	+/-2V	
Charging Algorithm	3-Step	
Joint Utility and Solar Charging		
INVERTER MODEL	3KVA with PWM	3KVA with MPPT
Max. Charging Current	110A	140A
Default Charging Current	60Amp	

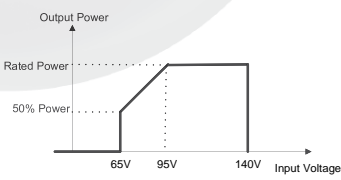
Table 4 General Specifications

INVERTER MODEL	3KVA with PWM SCC	3KVA with MPPT SCC
Safety Certification	CE	
Operating Temperature Range	0°C to 55°C	
Storage temperature	-15°C~ 60°C	
Dimension (D*W*H), mm	125 x 300 x 440	
Net Weight, kg	10.5	11

TROUBLESHOOTING

Problem	LCD/LED/Buzzer	Explanation / Possible cause	What to do
Unit shuts down automatically during startup process.	LCD/LEDs and buzzer will be active for 3 seconds and then completely off.	The battery voltage is too low (<1.91V/Cell)	1. Re-charge the battery. 2. Replace the battery.
No response after power on.	No indication.	1. The battery voltage is far too low. (<1.4V/Cell) 2. Battery polarity is connected reversely.	1. Check if batteries and the wiring are connected well. 2. Re-charge the battery. 3. Replace the battery.
Mains exist but the unit works in battery mode.	Input voltage is displayed as 0 on the LCD and green LED is flashing.	Input protector is tripped	Check if AC breaker is tripped and AC wiring is connected well.
	Green LED is flashing.	Insufficient quality of AC power. (Shore or Generator)	1. Check if AC wires are too thin and/or too long. 2. Check if generator (if applied) is working well or if the setting range of input voltage is correct. (UPS→Appliance)
	Green LED is flashing.	Set "Solar First" as the priority of output source.	Change output source priority to Utility first.
When the unit is turned on, internal relay is switched on and off repeatedly.	LCD display and LEDs are flashing	Battery is disconnected.	Check if battery wires are connected well.
Buzzer beeps continuously and red LED is on.	Fault code 07	Overload error. The inverter is overload by 110% and time is up.	Reduce the connected load by switching off some equipment.
	Fault code 05	Output short circuited.	Check if wiring is connected well and remove abnormal load.
		The temperature of internal converter is over 120°C. (Only available for 1-3KVA models.)	Check whether the air flow of the unit is blocked or whether the ambient temperature is too high.
	Fault code 02	The internal temperature of the inverter is over 100°C.	
	Fault code 03	Battery is over-charged.	Return to repair center.
		The battery voltage is too high.	Check if spec and quantity of the batteries meet the requirements.
	Fault code 01	Fan fault	Replace the fan.
	Fault code 06/58	Output abnormal (Inverter voltage is lower than 190Vac or is higher than 260Vac)	1. Reduce the connected load. 2. Return it to repair center
	Fault code 08/09/53/57	Internal components failed.	Return it to repair center.
	Fault code 51	Over current or surge.	Restart the unit, if the error happens again, please return it to repair center.
Fault code 52	Bus voltage is too low.		
Fault code 55	Output voltage is unbalanced.		
Fault code 56	Battery is not connected well or fuse is burnt.	If the battery is connected well, please return it to repair center.	

Appendix I: Approximate Back-up Time Table

Model	Load (VA)	Backup Time @24Vdc 100Ah (min)	Backup Time @24Vdc 200Ah (min)
3KVA	300	449	1100
	600	222	525
	900	124	303
	1200	95	227
	1500	68	164
	1800	56	126
	2100	48	108
	2400	35	94
	2700	31	74
3000	28	67	

Note: Backup time depends on the quality of the battery, age of battery and type of battery. Specifications of batteries may vary depending on different manufacturers.

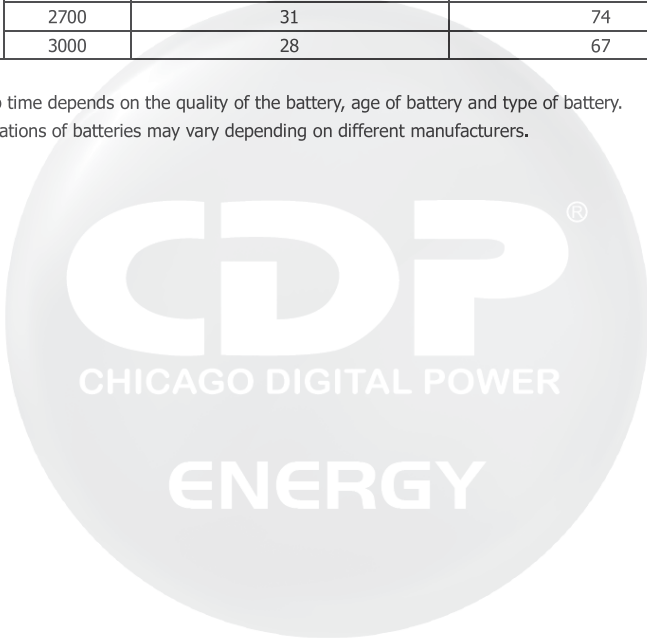

Appendix II: Parallel function

1. Introduction

This inverter can be used in parallel with two different operation modes.

1. Parallel operation in single phase with up to 6 units. The supported maximum output power is 14.4KW/18KVA.
2. Maximum six units work together to support three-phase equipment. Four units support one phase maximum. The supported maximum output power is 14.4KW/18KVA and one phase can be up to 9.6KW/12KVA.

NOTE: If this unit is bundled with shared current cable and parallel cable, this inverter supports parallel operation in default. You may skip section 3. If not, please purchase parallel kit and install this unit by following instruction from professional technical personnel in local dealer.

2. Package Contents

In parallel kit, you will find the following items in the package:



3. Parallel board installation

Step 1: Remove cover by loosening two screws as the diagram shown below.

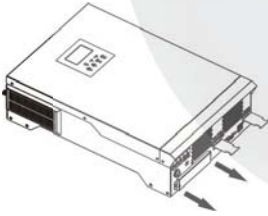

Step 3: Before installing parallel board inside of the inverter, be sure to connect 2-pin and 14-pin cables as shown in below chart.

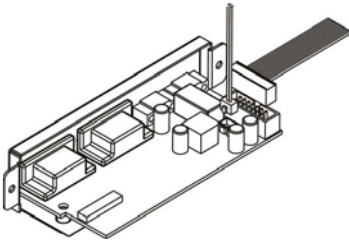

Step 4: Simply slide in the parallel board and fix it to the inverter with 2 screws tightly. Now the inverter is in parallel operation.

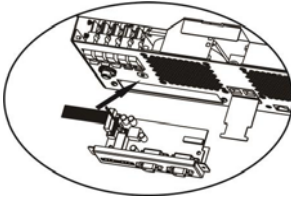

4. Mounting the Unit

When installing multiple units, please follow the illustration below.

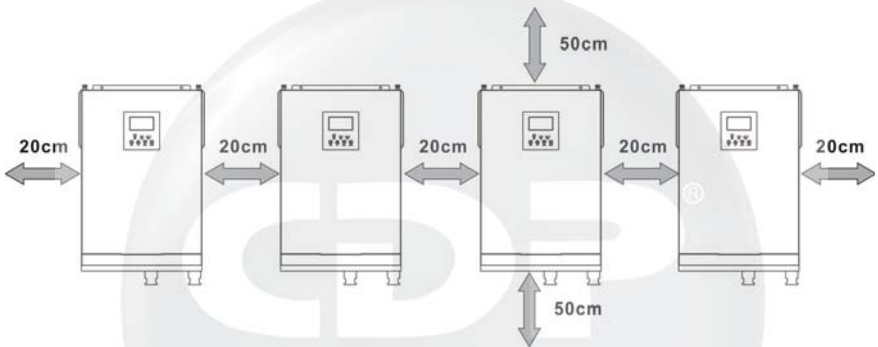

NOTE: For proper air circulation to dissipate heat, allow a clearance of approx. 20 cm to the side and approx. 50 cm above and below the unit. Be sure to install each unit in the same height.

5. Wiring Connection

The size of the cable for each inverter is shown as below:

WARNING: Be sure the length of all battery cables is the same. Otherwise, there will be voltage difference between inverter and battery which might cause mal-function of the parallel inverters.

Recommended battery cable and terminal size for each inverter:

Model	Wire Size	Torque value
3KVA	1*4AWG	2~ 3 Nm

Recommended cable size of AC input and output for each inverter:

Model	AWG no.	Torque
3KVA	8 AWG	1.4~1.6Nm

You need to connect the cables of each inverter together. Take the battery cables for example: You need to use a connector or bus-bar as a joint to connect the battery cables together, and then connect it to the battery terminal. The size of the cable used from joint to battery should be X times cable size in the tables above. "X" indicates the number of inverters connected in parallel.

Regarding AC input and output, please also follow the same principle.

CAUTION!! Please install the breaker at the battery and AC input side. This will ensure the inverter can be

securely disconnected during maintenance and fully protected from over current of battery or AC input. The recommended mounted location of the breakers is shown in the parallel diagrams in section 5-1 and 5-2.

Recommended specification of battery breaker for each inverter:

Model	1 unit*
3KVA	125A/30VDC

*If you want to use only one breaker at the battery side for the whole system, the rating of the breaker should be X times current of 1 unit. "X" indicates the number of inverters connected in parallel.

Recommended specification of AC input breaker in single phase:

Model	2 units	3 units	4 units	5 units	6 units
3KVA	80A/230VAC	120A/230VAC	160A/230VAC	200A/230VAC	240A/230VAC

Note 1: You also can use only one 40A breaker for each inverter at its AC input.

Note 2: Regarding three-phase system, you can use 3-pole breaker directly and the rating of the breaker should be compatible with the phase current limitation from the phase with maximum units.

Recommended battery capacity

Inverter parallel numbers	2	3	4	5	6
Battery Capacity	200AH	300AH	400AH	500AH	600AH

WARNING! Be sure that all inverters will share the same battery bank. Otherwise, the inverters will be transferred to fault mode.



5-1. Parallel Operation in Single phase

Two inverters in parallel:

Power Connection

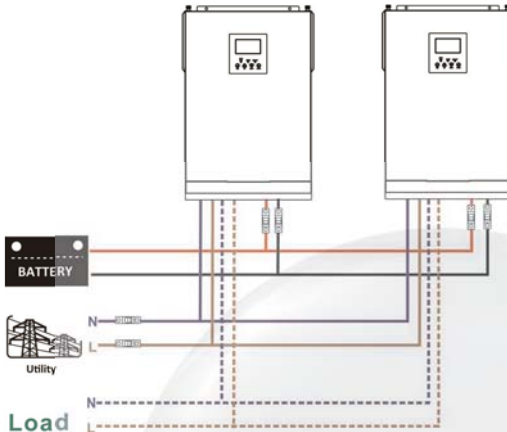

Communication Connection



Three inverters in parallel:

Power Connection

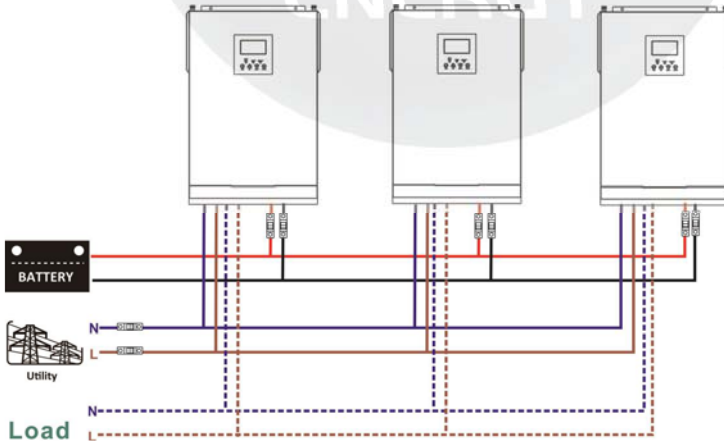

Communication Connection

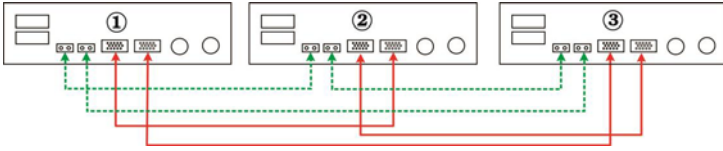

Four inverters in parallel:

Power Connection

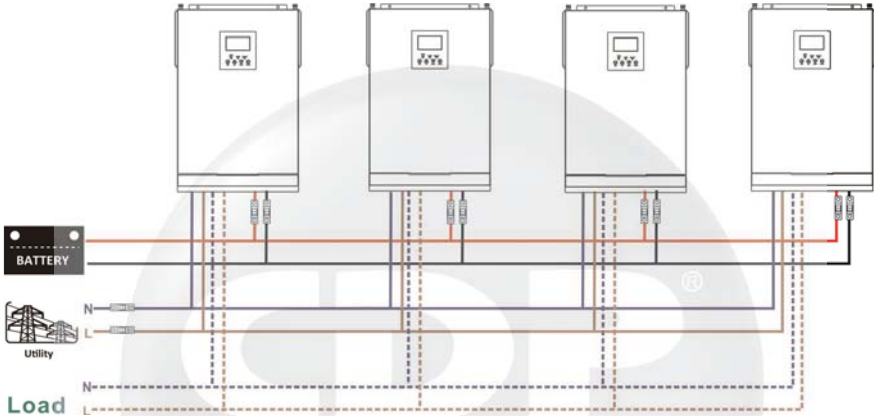

Communication Connection

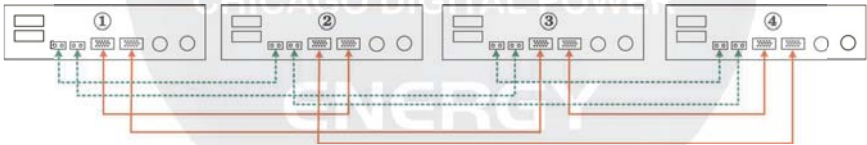

Five inverters in parallel:

Power Connection

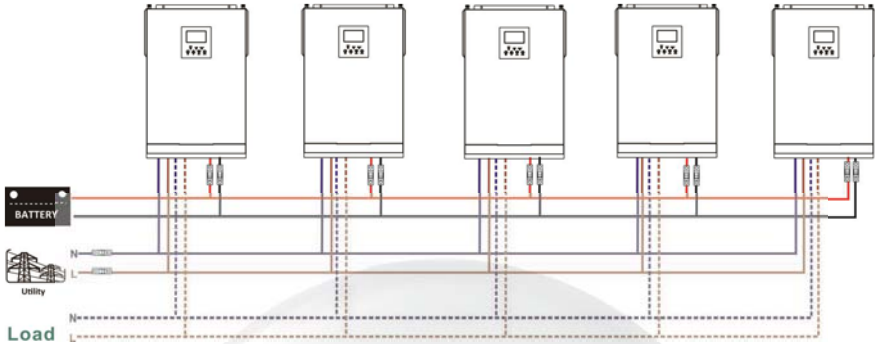

Communication Connection



Six inverters in parallel:

Power Connection

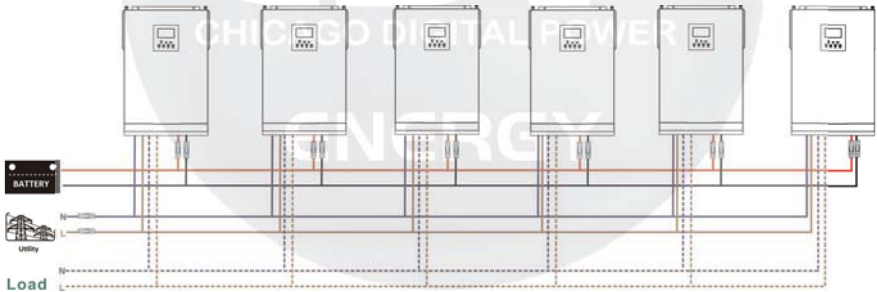

Communication Connection

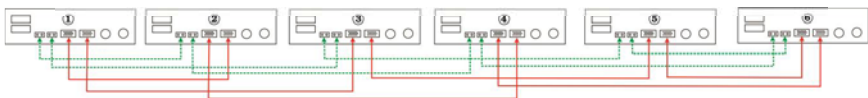

5-2. Support 3-phase equipment

Two inverters in each phase:

Power Connection

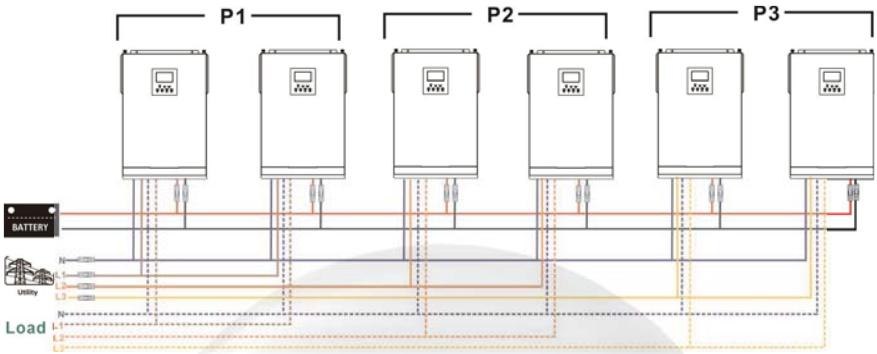

Communication Connection

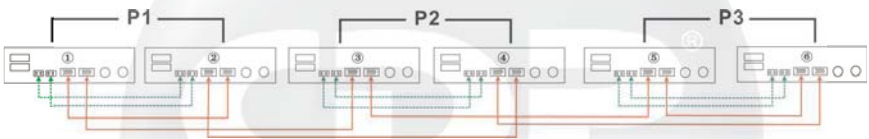

Four inverters in one phase and the rest two inverters for the other two phases:

Power Connection

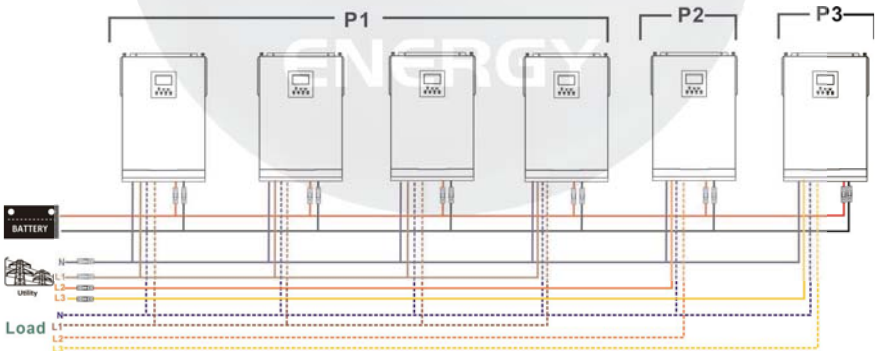

Note: It's up to customer's demand to pick 4 inverters on any phase.

P1: L1-phase, P2: L2-phase, P3: L3-phase.

Communication Connection

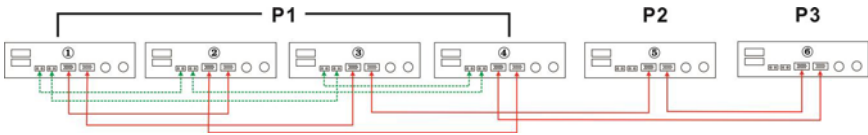

Three inverters in one phase, another two inverters in second phase and the other inverter for the third phase:

Power Connection

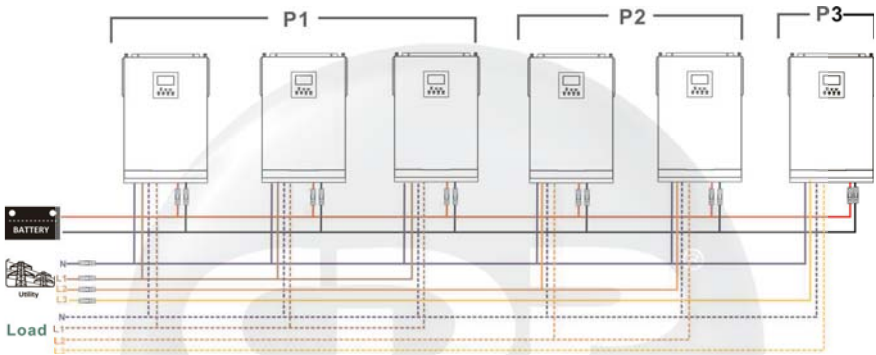

Communication Connection



Three inverters in one phase and only one inverter for each remaining phase:

Power Connection

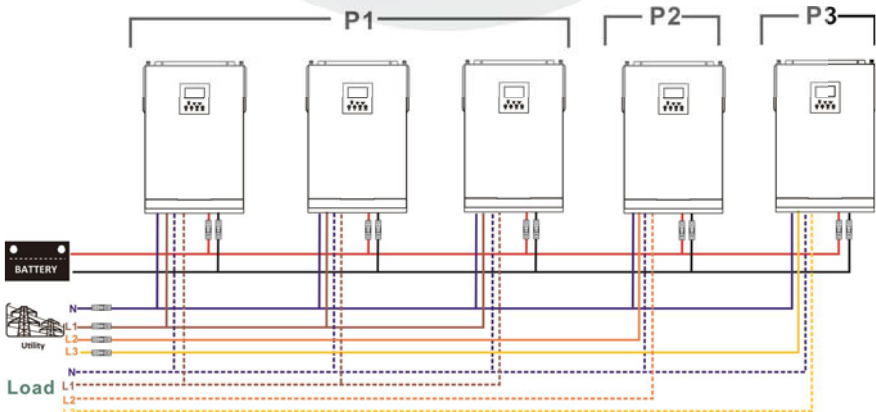

Communication Connection

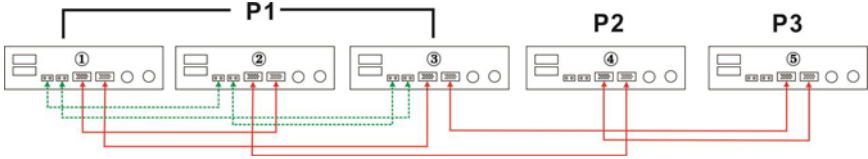

Two inverters in two phases and only one inverter for each remaining phase:

Power Connection

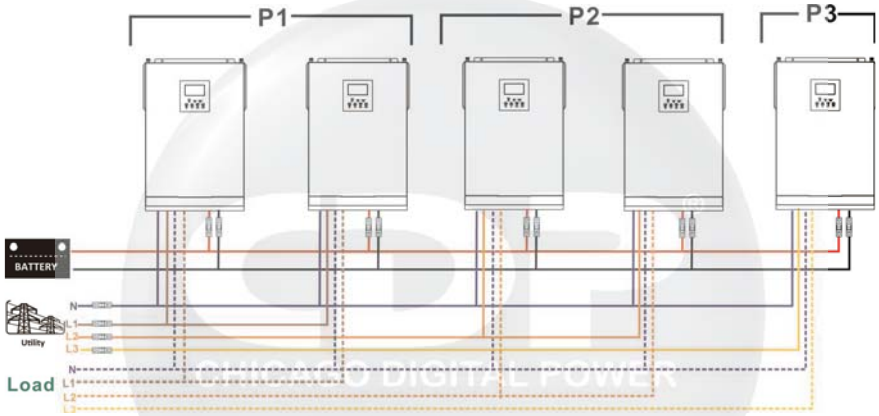

Communication Connection

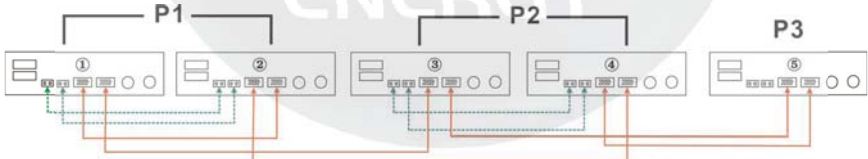

Two inverters in one phase and only one inverter for each remaining phase:

Power Connection

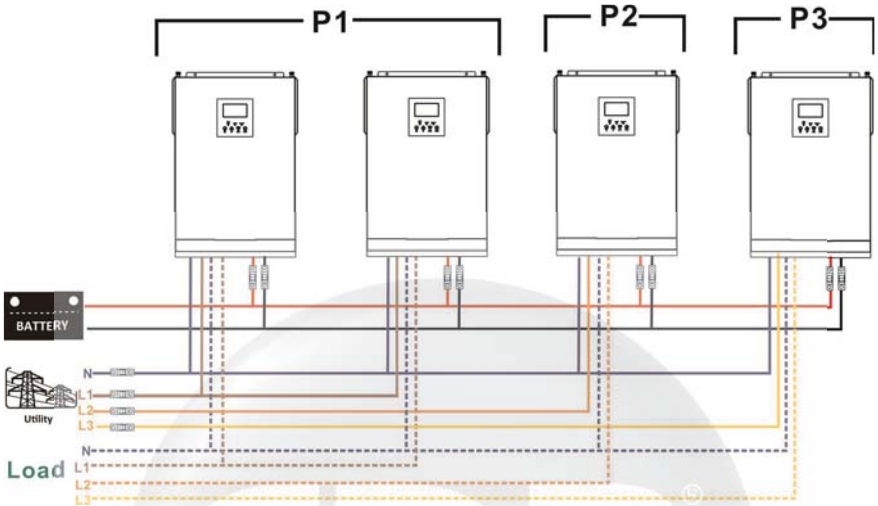

Communication Connection



One inverter in each phase:

Power Connection

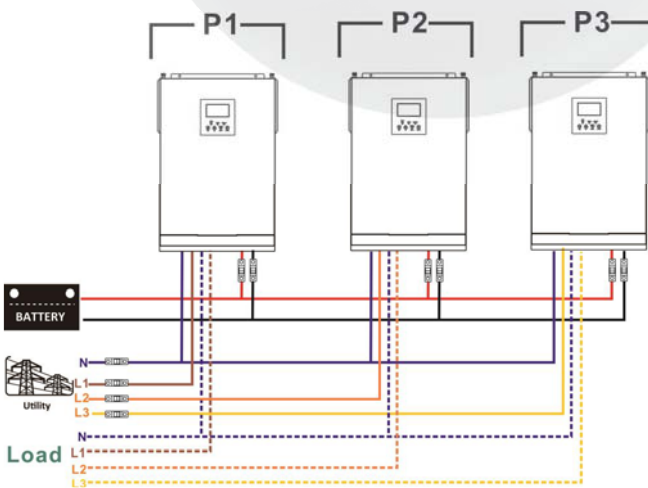

Communication Connection

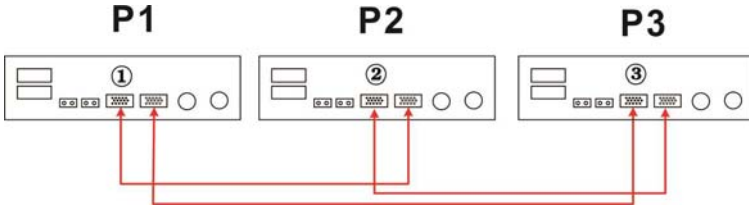

WARNING: Do NOT connect the current sharing cables between the inverters in different phases. Otherwise, it may damage the inverters.

6. PV Connection

Please refer to the user manual of single unit for PV Connection.

CAUTION: Each inverter should connect to PV modules separately.

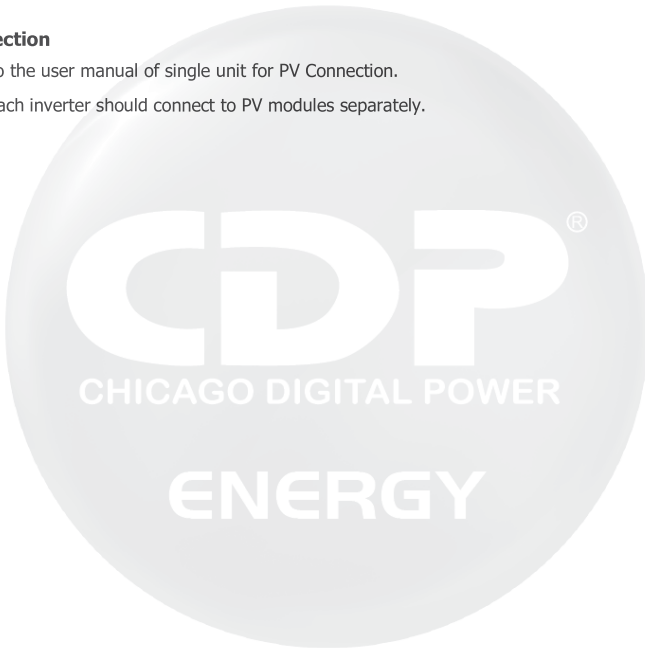

7. LCD Setting and Display

Setting Program:

Program	Description	Selectable option	
28	AC output mode *This setting is only available when the inverter is in standby mode (Switch off).	Single: 	When the units are used in parallel with single phase, please select "PAL" in program 28.
		Parallel: 	It is required to have at least 3 inverters or maximum 6 inverters to support three-phase equipment. It's required to have at least one inverter in each phase or it's up to four inverters in one phase. Please refers to 5-2 for detailed information. Please select "3P1" in program 28 for the inverters connected to L1 phase, "3P2" in program 28 for the inverters connected to L2 phase and "3P3" in program 28 for the inverters connected to L3 phase.
		L1 phase: 	
		L2 phase: 	Be sure to connect shared current cables to units in the same phase. Do NOT connect shared current cables between units in different phases.
		L3 phase: 	Besides, power saving function will be automatically disabled.
30	PV judge condition (Only apply for setting "Solar first" in program 1: Output source priority)	One Inverter (Default): 	When "ONE" is selected, as long as one of the inverters has been connected to PV modules and PV input is normal, parallel or 3-phase system will continue working according to rule of "solar first" setting. For example, two units are connected in parallel and set "SOL" in output source priority. If one of the two units has connected to PV modules and PV input is normal, the parallel system will provide power to loads from solar or battery power. If both of them are not sufficient, the system will provide power to loads from utility.
		All of Inverters: 	When "ALL" is selected, parallel or 3-phase system will continue working according to rule of "solar first" setting only when all of inverters are connected to PV modules. For example, two units are connected in parallel and set "SOL" in output source priority. When "ALL" is selected in program 30, it's necessary to have all inverters connected to PV modules and PV input is normal to allow the system to provide power to loads from solar and battery power. Otherwise, the system will provide power to loads from utility.

Fault code:

Fault Code	Fault Event	Icon on
60	Power feedback protection	60
71	Firmware version inconsistent	71
72	Current sharing fault	72
80	CAN fault	80
81	Host loss	81
82	Synchronization loss	82
83	Battery voltage detected different	83
84	Different AC input voltage and frequency detected	84
85	AC output current unbalance	85
86	AC output mode setting is different	86

8. Commissioning

Parallel in single phase

Step 1: Check the following requirements before installation:

- Correct wire connection
- Ensure all breakers in Line wires at load side are open and each Neutral wires of each unit is connected together.

Step 2: Turn on each unit and set "PAL" in LCD setting program 28 of each unit. And then shut down all units.

NOET: It's necessary to turn off switch when setting LCD program. Otherwise, the setting can not be programmed.

Step 3: Turn on each unit.

LCD display in Master unit	LCD display in Slave unit

NOTE: Master and slave units are randomly defined.

Step 4: Switch on all AC breakers of Line wires in AC input. It's better to connect all of the inverters to the utility at the same time. If not, it will display fault 82 in the following inverters. However, these inverters will automatically restart. If detecting AC connection, they will work normally.

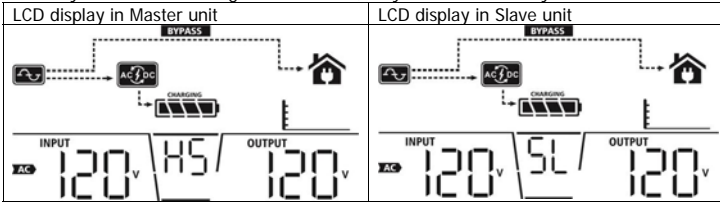

Step 5: If there is no more fault alarm, the parallel system is completely installed.

Step 6: Please switch on all breakers of Line wires in load side. This system will start to provide power to the load.

Support three-phase equipment

Step 1: Check the following requirements before installation:

- Correct wire connection
- Ensure all breakers in Line wires at load side are open and each Neutral wires of each unit is connected together.

Step 2: Turn on all of the units and configure LCD program 28 as P1, P2 and P3 sequentially. And then shut down all units.

NOET: It's necessary to turn off switch when setting LCD program. Otherwise, the setting can not be programmed.

Step 3: Turn on all units sequentially.

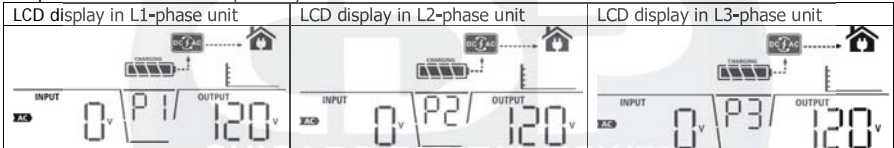

Step 4: Switch on all AC breakers of Line wires in AC input. If AC connection is detected and three phases are matched with unit setting, they will work normally. Otherwise, the AC icon will flash and they will not work in line mode. Under this circumstance, you can switch wires of AC inputs from L2 phase and L3 phase. Or you may exchange the LCD program 28 of P2 and P3 to solve this problem.

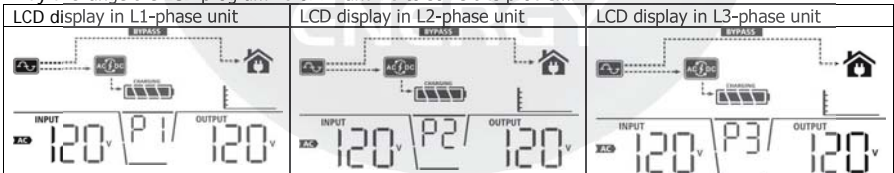

Step 5: If there is no more fault alarm, the system to support 3-phase equipment is completely installed.

Step 6: Please switch on all breakers of Line wires in load side. This system will start to provide power to the load.

Note 1: To avoid overload occurring, before turning on breakers at load side, it's better to have the whole system in operation first.

Note 2: There is some transfer time for this operation. Power interruption may happen to critical devices, which cannot tolerate transfer time.

9. Troubleshooting

If the device fails to function as expected, check the list of common faults below before consulting the service center.

Fault Code	Situation		Solution
	Fault Event Description		
60	Current feedback into the inverter is detected.		<ol style="list-style-type: none"> Restart the inverter. Check if L/N cables are not connected reversely in all inverters. For parallel system in single phase, make sure the current sharing cables are connected to all inverters. For supporting three-phase system, make sure the current sharing cables are connected to the inverters in the same phase, and disconnected to the inverters in different phases. If the problem remains, please contact your installer.
71	The firmware version of each inverter is not the same.		<ol style="list-style-type: none"> Update the firmware of all inverter to the same version. Check the version of each inverter via LCD setting and make sure the CPU versions are the same. If not, please contact your installer to provide the latest firmware to update. After updating, if the problem still remains, please contact your installer.
72	The output current of each inverter is different.		<ol style="list-style-type: none"> Check if shared cables are connected well and restart the inverter. If the problem remains, please contact your installer.
80	CAN data loss		<ol style="list-style-type: none"> Check if communication cables are connected well and restart the inverter. If the problem remains, please contact your installer.
81	Host data loss		
82	Synchronization data loss		
83	The battery voltage of each inverter is not the same.		<ol style="list-style-type: none"> Make sure all inverters share the same groups of batteries together. Remove all loads and disconnect AC input and PV input. Then, check battery voltage of all inverters. If the values from all inverters are close, please check if all battery cables are in the same length and in the same material type. Otherwise, please contact your installer to provide SOP to calibrate battery voltage of each inverter. If the problem still remains, please contact your installer.
84	AC input voltage and frequency are detected different.		<ol style="list-style-type: none"> Check the utility wiring connection and restart the inverter. Make sure utility starts up at same time. If there are breakers installed between utility and inverters, please be sure all AC input breakers can be turned on at same time. If the problem remains, please contact your installer.
85	AC output current unbalance		<ol style="list-style-type: none"> Restart the inverter. Remove some excessive loads and re-check the load information from LCD of the inverters. If the values are different, please check if AC input and output cables are in the same length and in the same material type. If the problem remains, please contact your installer.
86	AC output mode setting is different.		<ol style="list-style-type: none"> Switch off the inverter and check LCD setting #28. For parallel system in single phase, make sure no 3P1, 3P2 or 3P3 is set on #28. For supporting three-phase system, make sure no "PAL" is set on #28. If the problem remains, please contact your installer.

Enter this link to register your product.



Bolivia: 800-100156

Colombia: 01800-5181617

Costa Rica: 800-435737

El Salvador: 800-6773

Honduras: 800-25616099

México: 001800 514 8611

Panamá: 011-00800-2268611

Perú: 0800-54674

República Dominicana: 1888-7514876

Venezuela: 0800-1627485